



Carmex

Precision Tools Ltd.

x-treme thread cutting™

New

Threading Tools for the Oil & Gas Industries

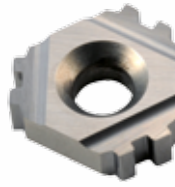
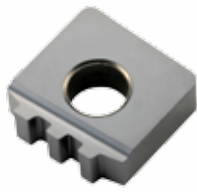



Carmex Precision Tools Ltd. is a leading manufacturer of high quality cutting tools. Carmex has been producing tools for the Oil and Gas industries for many years.

Product Lines

Carmex specializes in the production of threading tools for turning and milling. Our product lines include Thread Turning inserts and toolholders, Mill-Thread inserts and toolholders, Mill-Thread Solid Carbide and Spiral Mill-Thread. In addition to threading, we produce Grooving tools, Mini Chamfer mills, Swiss Tools and the Tiny Tools line of small boring bars for threading, turning and grooving of small parts.

Quality Assurance

Carmex is certified by ISO 9001:2008, ISO 13485:2003, ISO 14001:2004, OHSAS 18001 and CE.

This catalog includes the most popular items but we are able to offer solutions for various applications by using Carmex's large variety of product lines.



Thread Turning



Grooving



Mill-Thread



D-Thread



Specialized
Tools for
Fracking

Spiral Mill-Thread



Deep Reach



CMT



Mill-Thread Solid Carbide



Groove Milling

CONTENTS:	Page:	Page:
Vertical Inserts	2-4	Product Identification - Threading Toolholders 18
API	2	External Toolholders 19
API Buttress Casing	3	External Toolholders with top clamp 20
API Round	4	Vertical Toolholders
Chasers	5-9	Slim throat Toolholders
API Round	5	Internal Toolholders 21
API Buttress Casing	6	Internal Toolholders with coolant 22
OTTM Buttress Casing	6	Toolholders with top clamp
API Buttress Casing	7-8	Toolholders with 3.5° helix
OTTM Buttress Casing	8	Carbide shank Toolholders 23
API Buttress Casing	9	Vertical Toolholders
OTTM Buttress Casing	9	Thread helix angle 24
Standard Inserts	10-17	Standard and slanted anvils
Acme	10	Important points about carmex inserts 25
Stub Acme	11	Number of passes selection 26
NPT	12-13	Thread turning methods
NPTF	14	Carbide grade selection 27
API Round	15	Recommended cutting speed for thread turning inserts 28
OIL Threads	16	
Buttress Casing	17	
VAM	17	

Vertical API

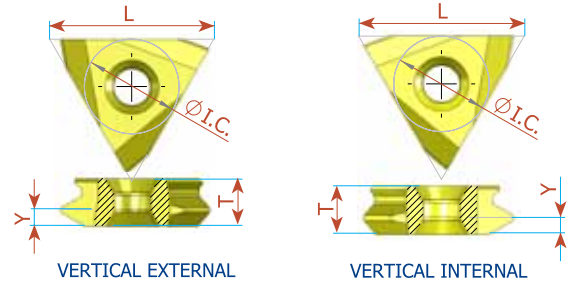
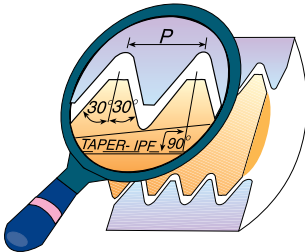

Thread Form	Pitch TPI	L	I.C. in	Taper IPF	EXTERNAL Ordering Code	Y	T	Connection No. or Size
V-0.040	5	27	5/8	3	TNMB 54 ER 5 API 403	2.5	6.4	2 3/8-4 1/2 REG
V-0.038R	4	27	5/8	2	TNMC 55 ER 4 API 382	2.8	7.94	NC23-NC50
V-0.038R	4	27	5/8	3	TNMC 55 ER 4 API 383	2.8	7.94	NC56-NC77
V-0.050	4	27	5/8	2	TNMC 55 ER 4 API 502	3.0	7.94	6 5/8 REG
V-0.050	4	27	5/8	3	TNMC 55 ER 4 API 503	3.0	7.94	5 1/2, 7 5/8, 8, 5/8 REG

Vertical inserts to be used with compatible holders in the market

Thread Form	Pitch TPI	L	I.C. in	Taper IPF	INTERNAL Ordering Code	Y	T	Connection No. or Size
V-0.040	5	27	5/8	3	TNMB 54 IR 5 API 403	2.5	6.4	2 3/8-4 1/2 REG
V-0.038R	4	27	5/8	2	TNMC 55 IR 4 API 382	2.8	7.94	NC23-NC50
V-0.038R	4	27	5/8	3	TNMC 55 IR 4 API 383	2.8	7.94	NC56-NC77
V-0.050	4	27	5/8	2	TNMC 55 IR 4 API 502	3.0	7.94	6 5/8 REG
V-0.050	4	27	5/8	3	TNMC 55 IR 4 API 503	3.0	7.94	5 1/2, 7 5/8, 8 5/8 REG

Vertical inserts to be used with compatible holders in the market

For Carbide Grade and Cutting Speed see page 27-28

Vertical API Buttress Casing

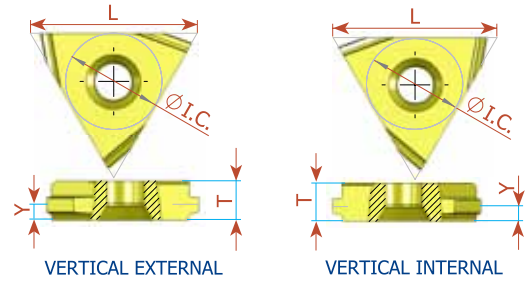
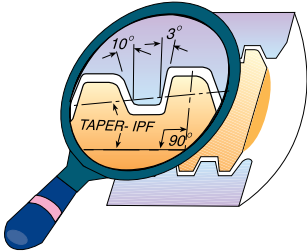

Pitch TPI	L	I.C. in	Taper IPF	EXTERNAL Ordering Code	Y	T	Connection No. or Size
5	27	5/8	0.75	TNMB 54 ER 5 BUT 0.75	2.4	6.4	4 1/2-13 3/8
5	27	5/8	0.75	TNMB 54 ER 5 BUT 1.0	2.4	6.4	16-20

Pitch TPI	L	I.C. in	Taper IPF	INTERNAL Ordering Code	Y	T	Connection No. or Size
5	27	5/8	0.75	TNMB 54 IR 5 BUT 0.75	2.4	6.4	4 1/2-13 3/8
5	27	5/8	0.75	TNMB 54 IR 5 BUT 1.0	2.4	6.4	16-20

Vertical inserts to be used with compatible holders in the market

For Carbide Grade and Cutting Speed see page 27-28

Vertical API Round

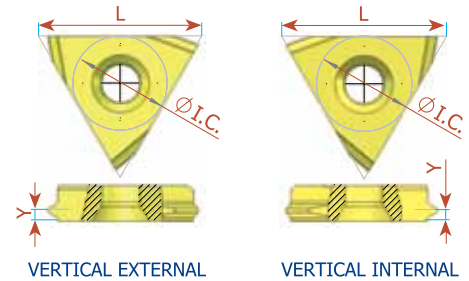
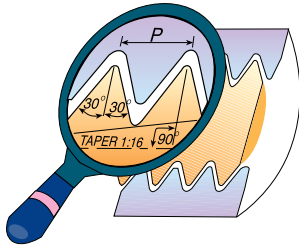

Pitch TPI	L	I.C. in	Taper IPF	EXTERNAL Ordering Code	Y	T
10	22	1/2	0.75	TNMB 43 ER 10 API RD	1.45	4.76
8	22	1/2	0.75	TNMB 43 ER 8 API RD	1.65	4.76

Pitch TPI	L	I.C. in	Taper IPF	INTERNAL Ordering Code	Y	T
10	22	1/2	0.75	TNMB 43 IR 10 API RD	1.45	4.76
8	22	1/2	0.75	TNMB 43 IR 8 API RD	1.65	4.76

Vertical inserts to be used with compatible holders in the market

For Carbide Grade and Cutting Speed see page 27-28

Chasers

API Round

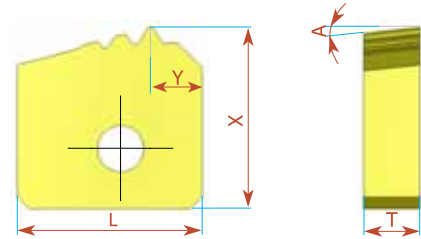

Pitch TPI	L	Taper IPF	EXTERNAL Ordering Code	X	Y	T	A	No. of Teeth
10	15.75	0.75	15.75 ER 10 API RD 3T	15.435	4.4	4.76	6°	3
8	15.75	0.75	15.75 ER 8 API RD 3T	15.84	4.4	4.76	6°	3

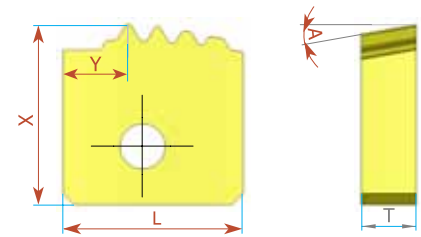

Pitch TPI	L	Taper IPF	INTERNAL Ordering Code	X	Y	T	A	No. of Teeth
10	15.75	0.75	15.75 IR 10 API RD 4T	15.75	5.7	4.76	10°	4
8	15.875	0.75	15.875 IR 8 API RD 4T	15.75	4.2	4.76	10°	4

Chasers to be used with compatible holders in the market

For Carbide Grade see page 27-28

Chasers

API Buttress Casing

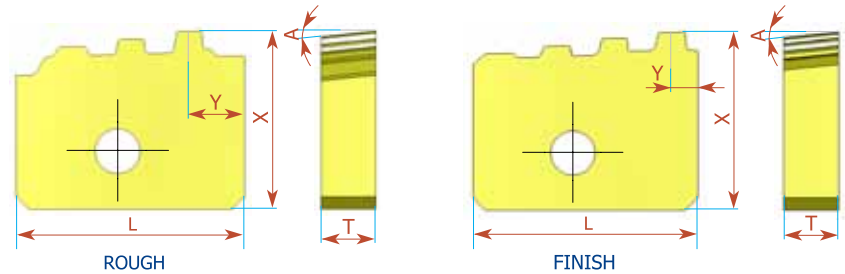

Pitch TPI	L	Taper IPF	EXTERNAL Ordering Code	X	Y	T	A	No. of Teeth
5	20	0.75	20 ER 5 BUT 0.75 R	15.435	4.84	4.76	6°	3
5	20	0.75	20 ER 5 BUT 0.75 F	15.875	2.3	4.76	6°	4

Chasers

OTTM Buttress Casing

Pitch TPI	L	Taper IPF	EXTERNAL Ordering Code	X	Y	T	A	No. of Teeth
5	20	0.75	20 ER 5 OTTM 0.75 R	15.692	4.79	4.76	6°	3
5	20	0.75	20 ER 5 OTTM 0.75 F	15.909	2.25	4.76	6°	4

Chasers to be used with compatible holders in the market

For Carbide Grade see page 27

Chasers

API Buttress Casing

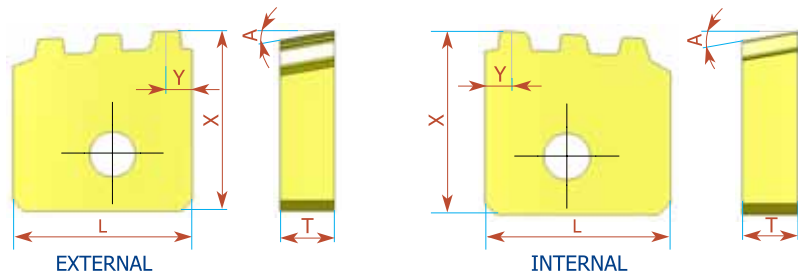

Pitch TPI	L	Taper IPF	EXTERNAL Ordering Code	X	Y	T	A	No. of Teeth
5	15.75	0.75	15.75 ER 5 BUT 0.75 3T	15.875	2.3	4.76	10°	3

Pitch TPI	L	Taper IPF	INTERNAL Ordering Code	X	Y	T	A	No. of Teeth
5	15.875	0.75	15.875 IR 5 BUT 0.75 3T	15.75	2.5	4.76	10°	3

Chasers

OTTM Buttress Casing

Pitch TPI	L	Taper IPF	EXTERNAL Ordering Code	X	Y	T	A	No. of Teeth
5	15.75	0.75	15.75 ER 5 OTTM 0.75 3T	15.75	3.0	4.76	6°	3

Pitch TPI	L	Taper IPF	INTERNAL Ordering Code	X	Y	T	A	No. of Teeth
5	15.875	0.75	15.875 IR 5 OTTM 0.75 3T	15.875	2.5	4.76	10°	3

Chasers to be used with compatible holders in the market

For Carbide Grade see page 27

Chasers

API Buttress Casing

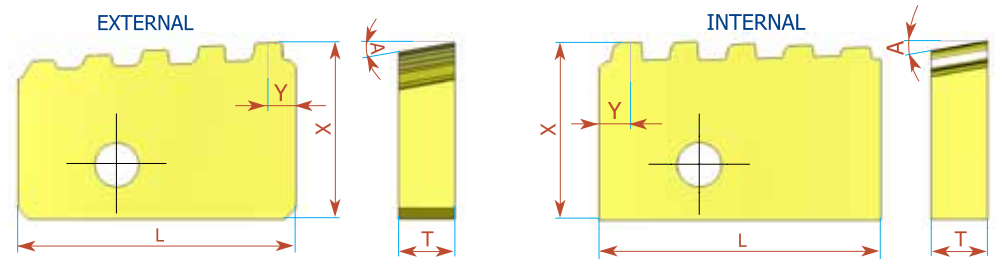

Pitch TPI	L	Taper IPF	EXTERNAL Ordering Code	X	Y	T	A	No. of Teeth
5	25	0.75	25 ER 5 BUT 0.75 5T	15.871	2.5	5	10°	5

Pitch TPI	L	Taper IPF	INTERNAL Ordering Code	X	Y	T	A	No. of Teeth
5	25	0.75	25 IR 5 BUT 0.75 5T	15.871	2.5	5	10°	5

Chasers

OTTM Buttress Casing

Pitch TPI	L	Taper IPF	INTERNAL Ordering Code	X	Y	T	A	No. of Teeth
5	25	0.75	25 IR 5 OTTM 0.75 5T	15.75	2.5	5	10°	5

Chasers to be used with compatible holders in the market

For Carbide Grade see page 27

Chasers

API Buttress Casing

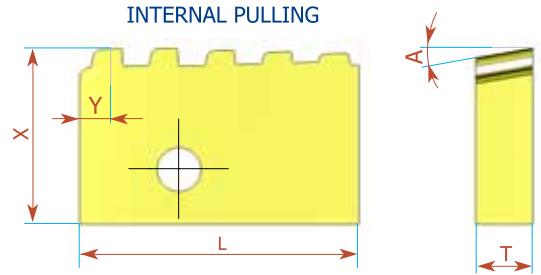

Pitch TPI	L	Taper IPF	INTERNAL Ordering Code	X	Y	T	A	No. of Teeth
5	25	0.75	25 IRP 5 BUT 0.75 5T	15.75	2.5	5	10°	5

Chasers

OTTM Buttress Casing

Pitch TPI	L	Taper IPF	INTERNAL Ordering Code	X	Y	T	A	No. of Teeth
5	25	0.75	25 IRP 5 OTTM 0.75 5T	15.75	2.5	5	10°	5

Chasers to be used with compatible holders in the market

For Carbide Grade see page 27

Acme

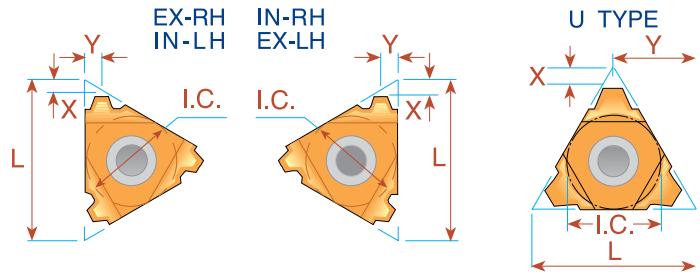
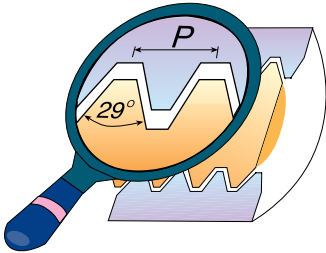

Pitch TPI	L	I.C. in	EXTERNAL		INTERNAL		X	Y
			Right Hand	Left Hand	Right Hand	Left Hand		
16	11	1/4	11 ER 16 ACME	11 EL 16 ACME	11 IR 16 ACME	11 IL 16 ACME	0.9	1.0
16	16	3/8	16 ER 16 ACME	16 EL 16 ACME	16 IR 16 ACME	16 IL 16 ACME	0.9	1.0
14	16	3/8	16 ER 14 ACME	16 EL 14 ACME	16 IR 14 ACME	16 IL 14 ACME	1.0	1.2
12	16	3/8	16 ER 12 ACME	16 EL 12 ACME	16 IR 12 ACME	16 IL 12 ACME	1.1	1.2
10	16	3/8	16 ER 10 ACME	16 EL 10 ACME	16 IR 10 ACME	16 IL 10 ACME	1.3	1.3
8	16	3/8	16 ER 8 ACME	16 EL 8 ACME	16 IR 8 ACME	16 IL 8 ACME	1.5	1.5
6	16	3/8	⁽¹⁾ 16 ER 6 ACME	⁽¹⁾ 16 EL 6 ACME	⁽¹⁾ 16 IR 6 ACME	⁽¹⁾ 16 IL 6 ACME	1.7	1.8
6	22	1/2	22 ER 6 ACME	22 EL 6 ACME	22 IR 6 ACME	22 IL 6 ACME	1.8	2.1
5	22	1/2	22 ER 5 ACME	22 EL 5 ACME	22 IR 5 ACME	22 IL 5 ACME	2.0	2.3
4	22U	1/2U	22U ER/L 4 ACME		22U IR/L 4 ACME		2.3	11.0
4	27	5/8	27 ER 4 ACME	27 EL 4 ACME	27 IR 4 ACME	27 IL 4 ACME	2.3	2.7
3	27U	5/8U	27U ER/L 3 ACME		27U IR/L 3 ACME		2.8	13.7
2	33U	3/4U	33U ER/L 2 ACME		33U IR/L 2 ACME		4.3	16.9

Order example: 16 ER 16 ACME MXC

(1) Special holder is required or standard holder can be amended by customer.

Acme Vertical

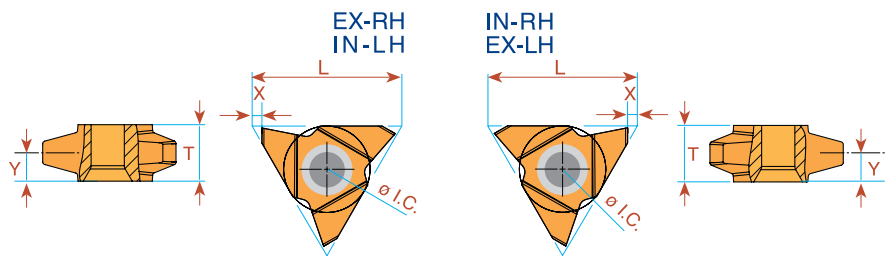

Pitch TPI	L	I.C. in	EXTERNAL		X	Y	T	INTERNAL		X	Y	T
			Right Hand	Left Hand				Right Hand	Left Hand			
* 3.5	27	5/8	27V ER 3.5 ACME	—	1.8	5.0	10.4	27V IR 3.5 ACME	—	1.8	4.0	10.4
* 3	27	5/8	27V ER 3 ACME	—	1.8	5.0	10.4	27V IR 3 ACME	—	1.8	4.6	10.4
** 2	27	5/8	27V ER 2 ACME	27V EL 2 ACME	1.8	5.0	10.4	27V IR 2 ACME	27V IL 2 ACME	1.8	5.0	10.4

Order example: 27V ER 2 ACME BMA

* Minimum bore: Ø55 mm ** Minimum bore: Ø76 mm

For Carbide Grade and Cutting Speed see page 27-28

Stub Acme

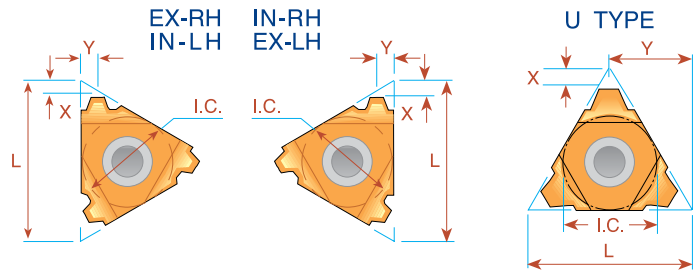
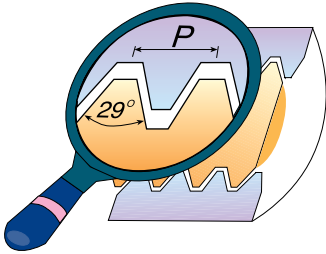

Pitch TPI	L	I.C. in	EXTERNAL		INTERNAL		X	Y
			Right Hand	Left Hand	Right Hand	Left Hand		
16	11	1/4	11 ER 16 STACME	11 EL 16 STACME			1.0	1.0
16	16	3/8	16 ER 16 STACME	16 EL 16 STACME	16 IR 16 STACME	16 IL 16 STACME	1.0	1.0
14	16	3/8	16 ER 14 STACME	16 EL 14 STACME	16 IR 14 STACME	16 IL 14 STACME	1.1	1.1
12	16	3/8	16 ER 12 STACME	16 EL 12 STACME	16 IR 12 STACME	16 IL 12 STACME	1.2	1.2
10	16	3/8	16 ER 10 STACME	16 EL 10 STACME	16 IR 10 STACME	16 IL 10 STACME	1.3	1.3
8	16	3/8	16 ER 8 STACME	16 EL 8 STACME	16 IR 8 STACME	16 IL 8 STACME	1.5	1.5
6	16	3/8	16 ER 6 STACME	16 EL 6 STACME	16 IR 6 STACME	16 IL 6 STACME	1.8	1.8
5	22	1/2	22 ER 5 STACME	22 EL 5 STACME	22 IR 5 STACME	22 IL 5 STACME	2.0	2.3
4	22	1/2	22 ER 4 STACME	22 EL 4 STACME	22 IR 4 STACME	22 IL 4 STACME	2.3	2.4
4	22U	1/2U	22U ER/L 4 STACME		22U IR/L 4 STACME		2.5	11.0
3	22U	1/2U	22U ER/L 3 STACME		22U IR/L 3 STACME		3.3	11.0
4	27	5/8	27 ER 4 STACME	27 EL 4 STACME	27 IR 4 STACME	27 IL 4 STACME	2.3	2.4
3	27	5/8	27 ER 3 STACME	27 EL 3 STACME	27 IR 3 STACME	27 IL 3 STACME	2.8	2.9
2	33U	3/4U	33U ER/L 2 STACME		33U IR/L 2 STACME		5.0	16.9

Order example: 22 IR 5 STACME MXC

For Carbide Grade and Cutting Speed see page 27-28

NPT

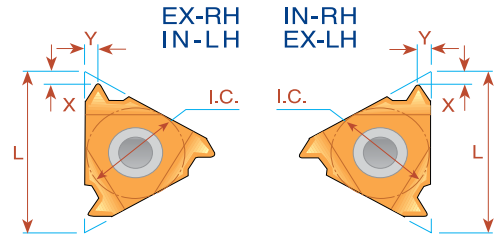
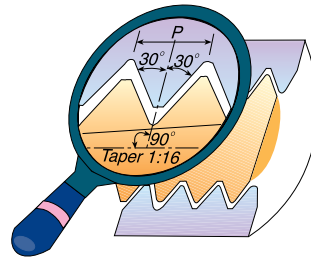

Pitch TPI	L	I.C. in	EXTERNAL		INTERNAL		X	Y
			Ordering Code Right Hand	Ordering Code Left Hand	Ordering Code Right Hand	Ordering Code Left Hand		
27	11	1/4	11 ER 27 NPT	11 EL 27 NPT	11 IR 27 NPT	11 IL 27 NPT	0.7	0.8
18	11	1/4	11 ER 18 NPT	11 EL 18 NPT	11 IR 18 NPT	11 IL 18 NPT	0.8	1.0
14	11	1/4	11 ER 14 NPT	11 EL 14 NPT	11 IR 14 NPT	11 IL 14 NPT	0.8	1.0
27	16	3/8	16 ER 27 NPT	16 EL 27 NPT	16 IR 27 NPT	16 IL 27 NPT	0.7	0.8
18	16	3/8	16 ER 18 NPT	16 EL 18 NPT	16 IR 18 NPT	16 IL 18 NPT	0.8	1.0
14	16	3/8	16 ER 14 NPT	16 EL 14 NPT	16 IR 14 NPT	16 IL 14 NPT	0.9	1.2
11.5	16	3/8	16 ER 11.5 NPT	16 EL 11.5 NPT	16 IR 11.5 NPT	16 IL 11.5 NPT	1.1	1.5
8	16	3/8	16 ER 8 NPT	16 EL 8 NPT	16 IR 8 NPT	16 IL 8 NPT	1.3	1.8

Order example: 16 ER 14 NPT MXC

Type B

Ground Profile with Sintered Chip-breaker

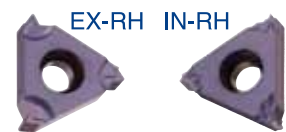

Pitch TPI	L	I.C. in	EXTERNAL	INTERNAL	X	Y
			Ordering Code Right Hand	Ordering Code Right Hand		
18	11	1/4		11 IR B 18 NPT	0.8	0.9
18	16	3/8	16 ER B 18 NPT	16 IR B 18 NPT	0.8	1.0
14	16	3/8	16 ER B 14 NPT	16 IR B 14 NPT	0.9	1.2
11.5	16	3/8	16 ER B 11.5 NPT	16 IR B 11.5 NPT	1.1	1.5
8	16	3/8	16 ER B 8 NPT	16 IR B 8 NPT	1.3	1.8

Order example: 16 IR B 11.5 NPT BMA

For Carbide Grade and Cutting Speed see page 27-28

NPT Multitooth

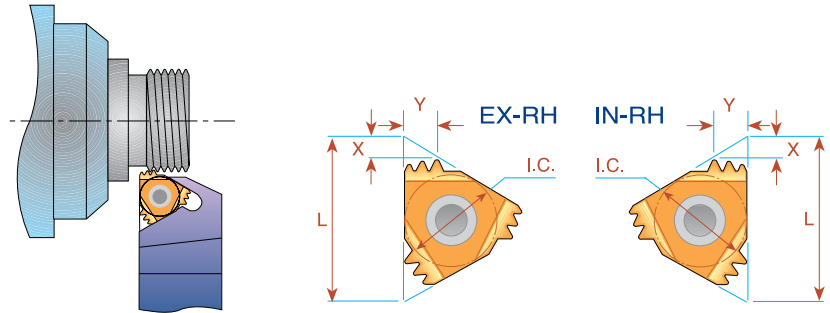

Pitch TPI	L	I.C. in	Number of Teeth	EXTERNAL		Anvil	INTERNAL		Anvil	X	Y
				Ordering Code			Ordering Code				
14	16	3/8	2	16 ER 14 NPT 2M		AE16M	16 IR 14 NPT 2M		AI16M	1.7	2.8
11.5	22	1/2	2	22 ER 11.5 NPT 2M		AE22M	22 IR 11.5 NPT 2M		AI22M	2.3	3.5
11.5	27	5/8	3	27 ER 11.5 NPT 3M		AE27M	27 IR 11.5 NPT 3M		AI27M	3.3	5.5
8	27	5/8	2	27 ER 8 NPT 2M		AE27M	27 IR 8 NPT 2M		AI27M	3.1	5.0

Order example: 22 ER 11.5 NPT 2M MXC

NPT Vertical

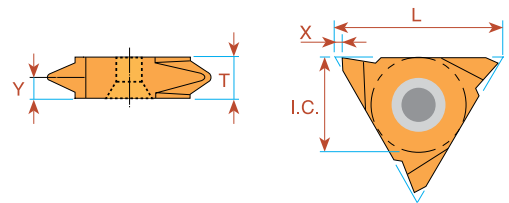

Pitch TPI	L	I.C. in	EXTERNAL		EXTERNAL		X	Y	T
			Ordering Code Right Hand		Ordering Code Left Hand				
27	16	3/8	16V ER 27 NPT		16V EL 27 NPT		1.0	0.8	3.6
18	16	3/8	16V ER 18 NPT		16V EL 18 NPT		1.0	1.0	3.6
14	16	3/8	16V ER 14 NPT		16V EL 14 NPT		1.0	1.2	3.6
11.5	16	3/8	16V ER 11.5 NPT		16V EL 11.5 NPT		1.0	1.5	3.6

Order example: 16V ER 14 NPT BMA

For Carbide Grade and Cutting Speed see page 27-28

NPTF - Dryseal

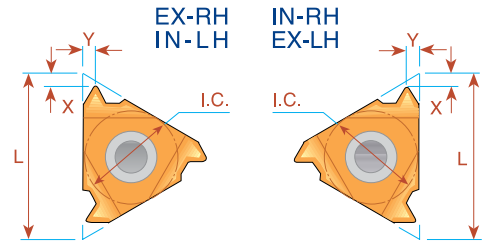
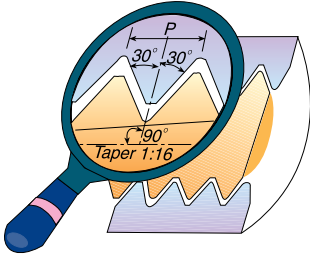

Pitch TPI	L	I.C. in	EXTERNAL		INTERNAL		X	Y
			Right Hand	Left Hand	Right Hand	Left Hand		
27	11	1/4	11 ER 27 NPTF	11 EL 27 NPTF	11 IR 27 NPTF	11 IL 27 NPTF	0.7	0.7
18	11	1/4	11 ER 18 NPTF	11 EL 18 NPTF	11 IR 18 NPTF	11 IL 18 NPTF	0.8	1.0
14	11	1/4	11 ER 14 NPTF	11 EL 14 NPTF	11 IR 14 NPTF	11 IL 14 NPTF	0.8	1.0
27	16	3/8	16 ER 27 NPTF	16 EL 27 NPTF	16 IR 27 NPTF	16 IL 27 NPTF	0.7	0.7
18	16	3/8	16 ER 18 NPTF	16 EL 18 NPTF	16 IR 18 NPTF	16 IL 18 NPTF	0.8	1.0
14	16	3/8	16 ER 14 NPTF	16 EL 14 NPTF	16 IR 14 NPTF	16 IL 14 NPTF	0.9	1.2
11.5	16	3/8	16 ER 11.5 NPTF	16 EL 11.5 NPTF	16 IR 11.5 NPTF	16 IL 11.5 NPTF	1.1	1.5
8	16	3/8	16 ER 8 NPTF	16 EL 8 NPTF	16 IR 8 NPTF	16 IL 8 NPTF	1.3	1.8

Order example: 11 ER 27 NPTF MXC

Type B

Ground Profile with Sintered Chip-breaker

Pitch TPI	L	I.C. in	INTERNAL Ordering Code Right Hand	X	Y
18	11	1/4	11 IR B 18 NPTF	0.8	0.9



Multitooth

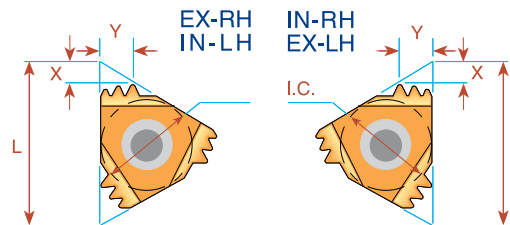
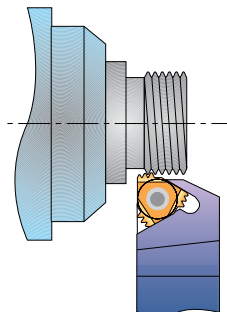

Pitch TPI	L	I.C. in	Number of Teeth	EXTERNAL Ordering Code	Anvil	INTERNAL Ordering Code	Anvil	X	Y
11.5	22	1/2	2	22 ER 11.5 NPTF 2M	AE22M	22 IR 11.5 NPTF 2M	AI22M	2.3	3.5

For Carbide Grade and Cutting Speed see page 27-28

OIL Threads API Round

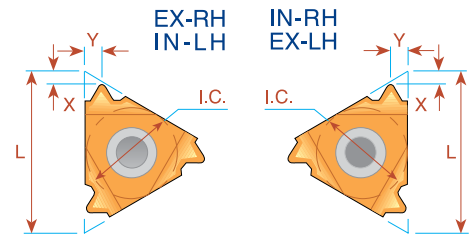
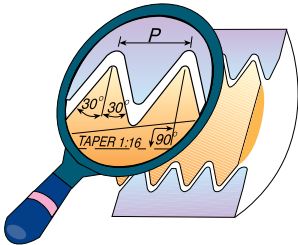

Pitch TPI	L	I.C. in	Taper IPF	EXTERNAL Ordering Code Right Hand	INTERNAL Ordering Code Right Hand	X	Y
10	16	3/8	0.75	16 ER 10 API RD	16 IR 10 API RD	1.5	1.4
8	16	3/8	0.75	16 ER 8 API RD	16 IR 8 API RD	1.3	1.6

Multitooth

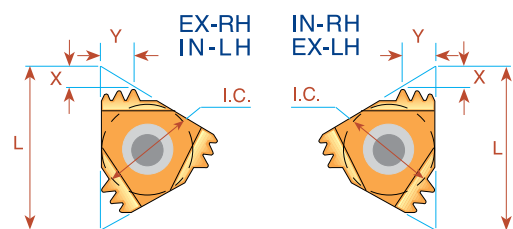
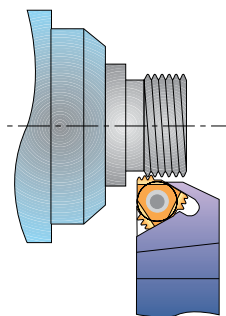

Pitch TPI	L	I.C. in	Number of Teeth	EXTERNAL Ordering Code	Anvil	INTERNAL Ordering Code	Anvil	X	Y
10	22	1/2	2	22 ER 10API RD 2M	AE22M	22 IR 10API RD 2M	AI22M	2.4	3.7
10	27	5/8	3	27 ER 10API RD 3M	AE27M	27 IR 10API RD 3M	AI27M	3.8	6.2
8	27	5/8	2	27 ER 8API RD 2M	AE27M	27 IR 8API RD 2M	AI27M	3.0	4.5

Order example: 27 IR 10 API RD 3M MXC

For Carbide Grade and Cutting Speed see page 27-28

OIL Threads

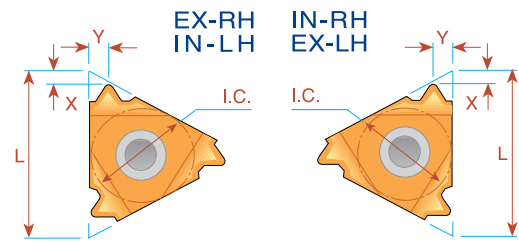
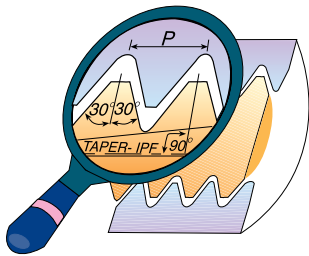

V-0.040

Pitch TPI	L	I.C. in	Taper IPF	EXTERNAL	INTERNAL	X	Y	Connection No. or Size
				Ordering Code Right Hand	Ordering Code Right Hand			
5	22	1/2	3	22 ER 5 API 403	22 IR 5 API 403	1.8	2.5	23/8-4 1/2 REG

V-0.038R

Pitch TPI	L	I.C. in	Taper IPF	EXTERNAL	INTERNAL	X	Y	Connection No. or Size
				Ordering Code Right Hand	Ordering Code Right Hand			
4	27	5/8	2	27 ER 4 API 382	27 IR 4 API 382	2.1	2.8	NC23-NC50
4	27	5/8	3	27 ER 4 API 383	27 IR 4 API 383	2.1	2.8	NC56-NC77

V-0.050

Pitch TPI	L	I.C. in	Taper IPF	EXTERNAL	INTERNAL	X	Y	Connection No. or Size
				Ordering Code Right Hand	Ordering Code Right Hand			
4	27	5/8	2	27 ER 4 API 502	27 IR 4 API 502	2.0	3.0	65/8 REG
4	27	5/8	3	27 ER 4 API 503	27 IR 4 API 503	2.0	3.0	5 1/2, 7 5/8, 8 5/8 REG

V-0.055

Macaroni Tubing (MT)

American Macaroni Tubing (AMT)

American Mining Macaroni Tubing (AMMT)

Pitch TPI	L	I.C. in	Taper IPF	EXTERNAL	INTERNAL	X	Y	Connection No. or Size
				Ordering Code Right Hand	Ordering Code Right Hand			
6	22	1/2	1.5	22 ER 6 API 551.5	-	2.0	1.7	NC10,NC12,NC13,NC16
6	16	3/8	1.5	-	16 IR 6 API 551.5	2.0	1.7	NC10,NC12,NC13 *
6	22	1/2	1.5	-	22 IR 6 API 551.5	2.0	1.7	NC16 **

* For NC10,NC12 use holder SIR0016P16CB
For NC13 use holders SIR0020P16/SIR0020P16B/SIR0020S16CB

** For NC16 use holder SIR0025R22

OIL Threads Extreme - Line Casing

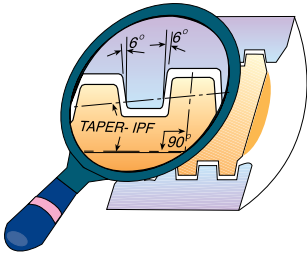

Pitch TPI	L	I.C. in	Taper IPF	EXTERNAL	INTERNAL	X	Y	Connection No. or Size
				Ordering Code Right Hand	Ordering Code Right Hand			
6	22	1/2	1.50	22 ER 6 EL 1.5	22 IR 6 EL 1.5	1.9	1.9	5-7 ⁵ / ₈
5	22	1/2	1.25	22 ER 5 EL 1.25	22 IR 5 EL 1.25	2.4	2.3	8 ⁵ / ₈ -10 ³ / ₄

Buttress Casing

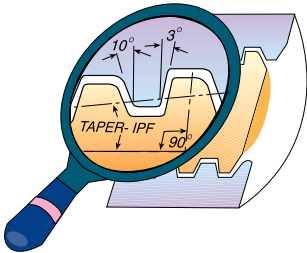

Pitch TPI	L	I.C. in	Taper IPF	EXTERNAL	INTERNAL	X	Y	Connection No. or Size
				Ordering Code Right Hand	Ordering Code Right Hand			
5	22	1/2	0.75	22 ER 5 BUT 0.75	22 IR 5 BUT 0.75	2.2	2.4	4 ¹ / ₂ -13 ³ / ₈
5	22	1/2	1.00	22 ER 5 BUT 1.0	22 IR 5 BUT 1.0	2.3	2.4	16-20

Order example: 22 ER 5 BUT 0.75 MXC

VAM

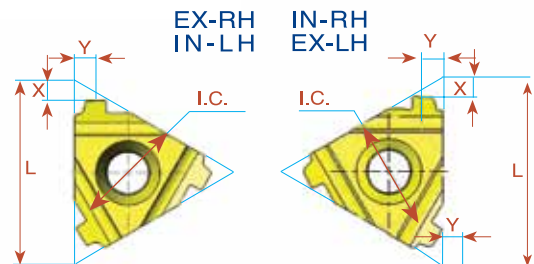
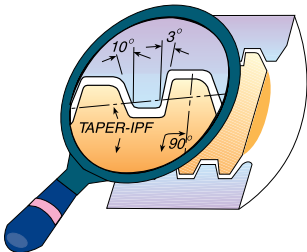

Pitch TPI	L	I.C. in	Taper IPF	EXTERNAL	X	Y	INTERNAL	X	Y	Connection No. or Size
				Ordering Code Right Hand			Ordering Code Right Hand			
8	16	3/8	0.75	16 ER 8 VAM	1.7	1.8	16 IR 8 VAM	1.7	1.8	2 ³ / ₈ "-2 ⁷ / ₈ "
6	22	1/2	0.75	22 ER 6 VAM	2.4	2.4	22 IR 6 VAM	2.5	2.5	3 ¹ / ₂ "-4 ¹ / ₂ "
5	22	1/2	0.75	22 ER 5 VAM	2.4	2.7	22 IR 5 VAM	2.4	2.5	5"-13 ³ / ₈ "

Order example: 16 ER 8 VAM BMA

For Carbide Grade and Cutting Speed see page 27-28

Product Identification

Threading Toolholders Ordering Codes

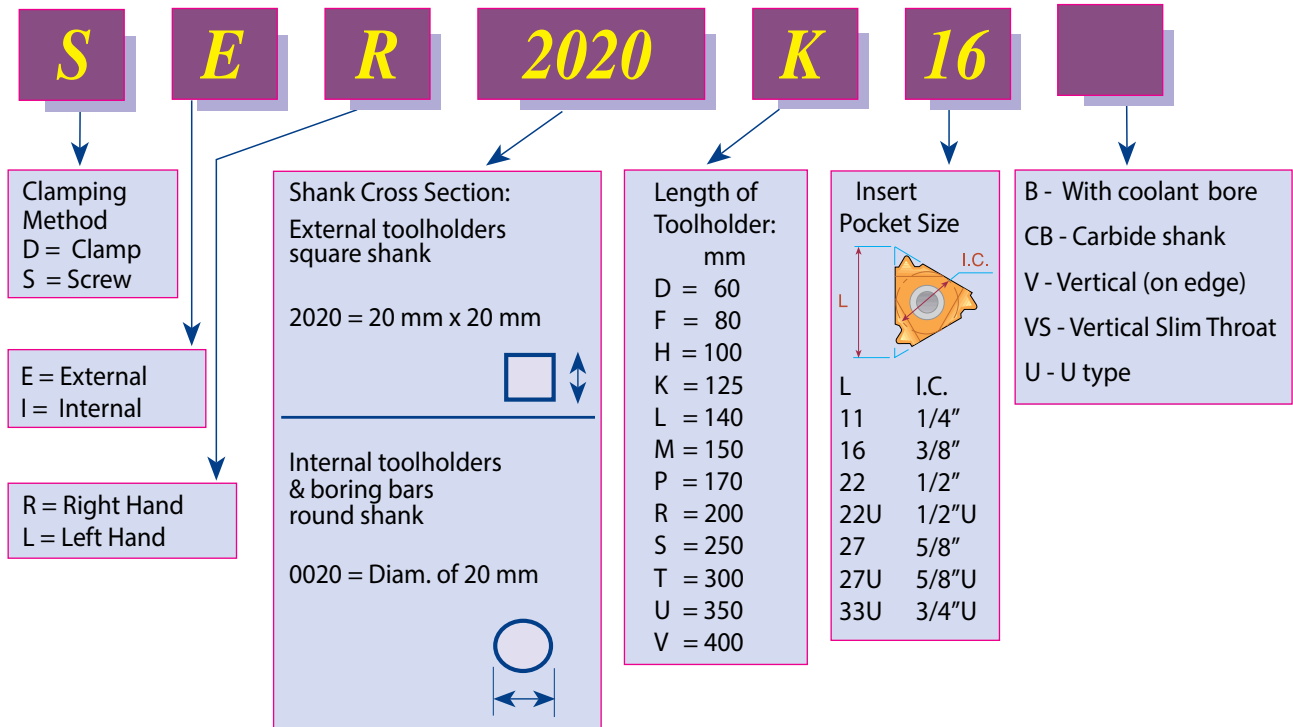

External Toolholders

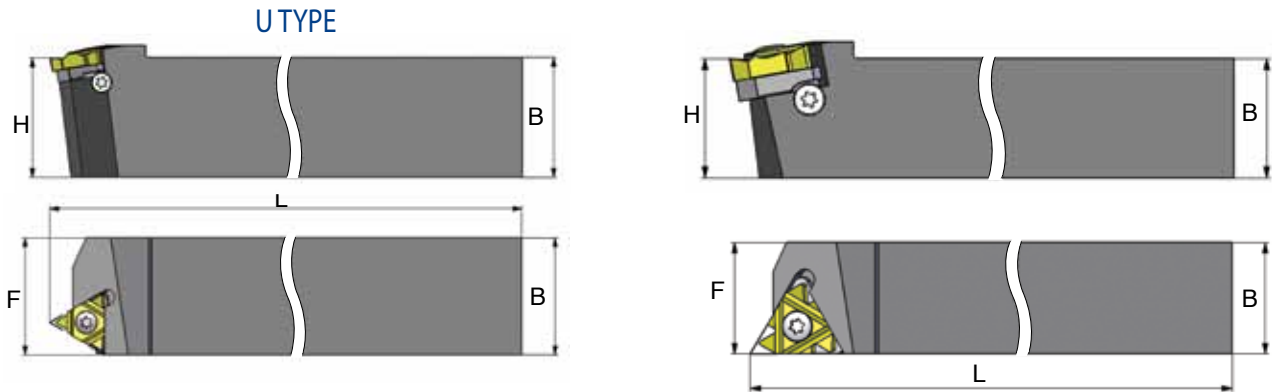

Ordering Code Right Hand	 L	B=H	L	F	Insert Screw	Anvil Screw	Torx Key	RH Anvil	LH Anvil
*SER 8 8 H11	11	8	100	11	S11	-	K11	-	-
*SER 10 10 H11	11	10	100	11	S11	-	K11	-	-
SER 12 12 F16	16	12	80	16	S16	A16	K16	AE16	AI16
SER 16 16 H16	16	16	100	16	S16	A16	K16	AE16	AI16
SER 20 20 K16	16	20	125	20	S16	A16	K16	AE16	AI16
SER 25 25 M16	16	25	150	25	S16	A16	K16	AE16	AI16
SER 32 32 P16	16	32	170	32	S16	A16	K16	AE16	AI16
SER 25 25 M22	22	25	150	25	S22	A22	K22	AE22	AI22
SER 32 32 P22	22	32	170	32	S22	A22	K22	AE22	AI22
SER 40 40 R22	22	40	200	40	S22	A22	K22	AE22	AI22
SER 25 25 M22U	22U	25	150	28	S22	A22	K22	AE22U	AI22U
SER 32 32 P22U	22U	32	170	32	S22	A22	K22	AE22U	AI22U
SER 40 40 R22U	22U	40	200	40	S22	A22	K22	AE22U	AI22U
SER 25 25 M27	27	25	150	32	S27	A27	K27	AE27	AI27
SER 32 32 P27	27	32	170	32	S27	A27	K27	AE27	AI27
SER 40 40 R27	27	40	200	40	S27	A27	K27	AE27	AI27
SER 25 25 M27U	27U	25	150	32	S27	A27	K27	AE27U	AI27U
SER 32 32 P27U	27U	32	170	32	S27	A27	K27	AE27U	AI27U
SER 40 40 R27U	27U	40	200	40	S27	A27	K27	AE27U	AI27U
*SER 25 25 M33U	33U	25	150	32	S33	-	K33	-	-
*SER 32 32 P33U	33U	32	170	32	S33	-	K33	-	-

*Toolholders with no anvil

For **LEFT HAND** toolholders specify **SEL** instead of **SER**

Toolholders are made with a **1.5° Helix Angle**. For other Helix Angles see page 24.

External toolholders with top clamp

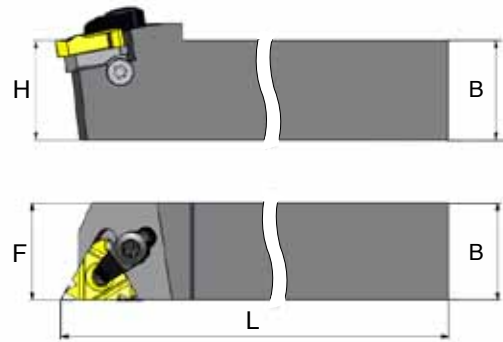

Ordering Code Right Hand	L	B=H	L	F	Insert Screw	Clamp	Anvil Screw	Torx Key	RH Anvil	LH Anvil
DER 2020 K16	16	20	125	20	S16	C16	A16S	K16	AE16	AI16
DER 2525 M16	16	25	150	25	S16	C16	A16S	K16	AE16	AI16
*DER 2525 M22	22	25	150	25	S22	C22	A22	K22	AE22	AI22

For **LEFT HAND** toolholders specify **DEL** instead of **DER**

Toolholders are made with a **1.5° Helix Angle**. For other Helix Angles please consult helix angle chart in the technical section of this catalogue.

Two clamping methods can be used: screw or top clamp.

*Use K21 torx key for C22 clamp

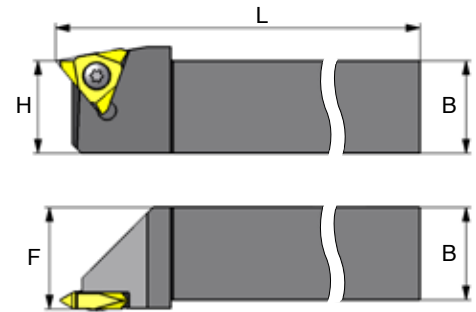

Vertical toolholders



Ordering Code Right Hand	L	B=H	L	F	Insert Screw	Torx Key
SER 2020 K16V	16	20	125	22	S16S	K16
SER 2525 M16V	16	25	150	27	S16S	K16
SER 2525 M22V	22	25	150	27.5	S22S	K22
SER 3232 P27V-T10	27	32	170	36	S27	K27

Slim Throat toolholders

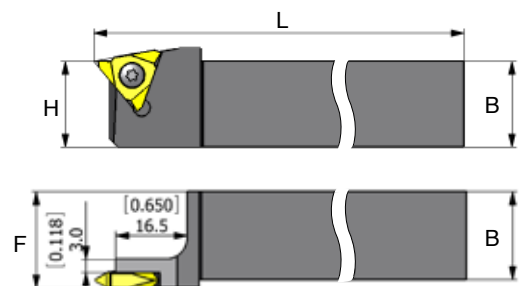

Ordering Code Right Hand	L	B=H	L	F	Insert Screw	Torx Key
SER 1616 H16VS	16	16	100	18	S16S	K16
SER 2020 K16VS	16	20	125	22	S16S	K16
SER 2525 M16VS	16	25	150	27	S16S	K16

Internal Toolholders

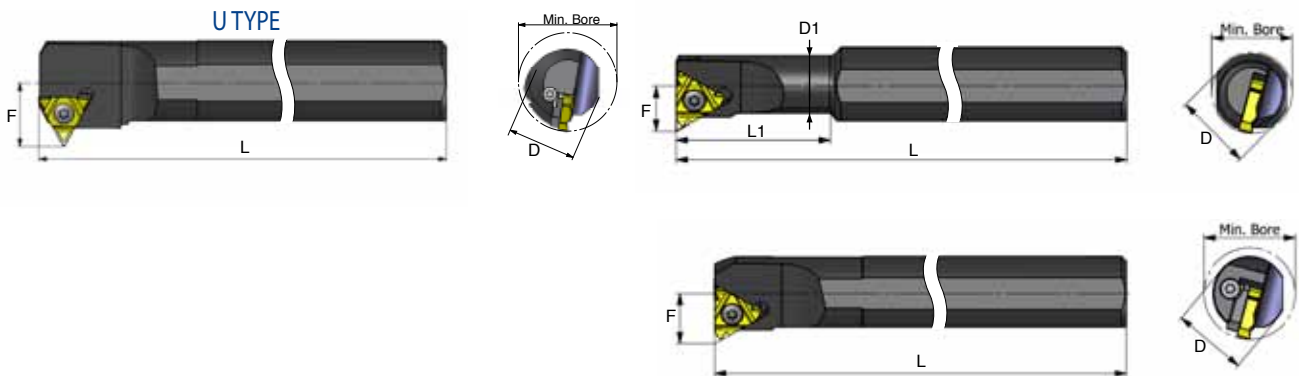

Ordering Code Right Hand	 L	D	D1	Min Bore Diam.	L	L1	F	Insert Screw	Anvil Screw	Torx Key	RH Anvil	LH Anvil
*SIR 0010 H11	11	10	10	12	100	-	7.4	S11	-	K11	-	-
*SIR 0010 K11	11	16	10	12	125	25	7.4	S11	-	K11	-	-
*SIR 0013 L11	11	16	13	15	140	32	8.9	S11	-	K11	-	-
*SIR 0013 M16	16	16	13	16	150	32	10.2	S16S	-	K16	-	-
*SIR 0016 P16	16	20	16	19	170	40	11.7	S16S	-	K16	-	-
SIR 0020 P16	16	20	20	24	170	-	13.7	S16	A16	K16	AI16	AE16
SIR 0025 R16	16	25	25	29	200	-	16.2	S16	A16	K16	AI16	AE16
SIR 0032 S16	16	32	32	36	250	-	19.7	S16	A16	K16	AI16	AE16
SIR 0040 T16	16	40	40	44	300	-	23.7	S16	A16	K16	AI16	AE16
*SIR 0020 P22	22	20	20	24	170	-	15.6	S22S	-	K22	-	-
SIR 0025 R22	22	25	25	29	200	-	18.1	S22	A22	K22	AI22	AE22
SIR 0032 S22	22	32	32	38	250	-	21.6	S22	A22	K22	AI22	AE22
SIR 0040 T22	22	40	40	46	300	-	25.6	S22	A22	K22	AI22	AE22
SIR 0032 S22U	22U	32	32	38	250	-	24.4	S22	A22	K22	AI22U	AE22U
SIR 0040 T22U	22U	40	40	46	300	-	28.1	S22	A22	K22	AI22U	AE22U
SIR 0032 S27	27	32	32	40	250	-	22.6	S27	A27	K27	AI27	AE27
SIR 0040 T27	27	40	40	48	300	-	26.6	S27	A27	K27	AI27	AE27
SIR 0050 U27	27	50	50	58	350	-	31.6	S27	A27	K27	AI27	AE27
SIR 0060 V27	27	60	60	68	400	-	36.6	S27	A27	K27	AI27	AE27
SIR 0032 S27U	27U	32	32	40	250	-	25.8	S27	A27	K27	AI27U	AE27U
SIR 0040 T27U	27U	40	40	48	300	-	29.4	S27	A27	K27	AI27U	AE27U
SIR 0050 U27U	27U	50	50	58	350	-	34.4	S27	A27	K27	AI27U	AE27U
SIR 0060 V27U	27U	60	60	68	400	-	39.7	S27	A27	K27	AI27U	AE27U
*SIR 0050 U33U	33U	50	50	62	350	-	37.5	S33	-	K33	-	-

*Toolholders with no anvil

For **LEFT HAND** toolholders specify **SIL** instead of **SIR**

Toolholders are made with a **1.5° Helix Angle**. For other Helix Angles see page 24.

Internal toolholders with coolant bore

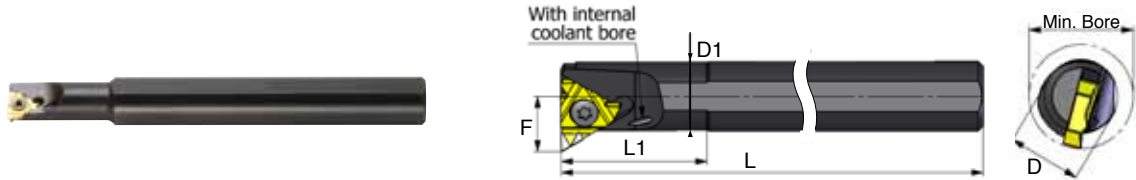

Ordering Code Right Hand	 L	D	D1	Min Bore Diam.	L	L1	F	Insert Screw	Anvil Screw	Torx Key	RH Anvil	LH Anvil
*SIR 0010 K11B	11	16	10	12	125	25	7.4	S11	-	K11	-	-
*SIR 0013 M16B	16	16	13	16	150	32	10.2	S16S	-	K16	-	-
*SIR 0016 P16B	16	20	16	19	170	40	11.7	S16S	-	K16	-	-
SIR 0020 P16B	16	20	20	24	170	-	13.7	S16	A16	K16	AI16	AE16
SIR 0025 R16B	16	25	25	29	200	-	16.2	S16	A16	K16	AI16	AE16
SIR 0025 R22B	22	25	25	29	200	-	18.1	S22	A22	K22	AI22	AE22

*Toolholders with no anvil

For **LEFT HAND** toolholders specify SIL instead of SIR

Toolholders are made with a **1.5° Helix Angle**. For other Helix Angles see page 24.

Internal toolholders with top clamp

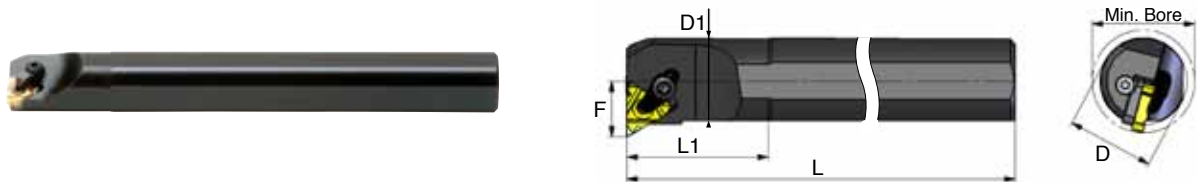

Ordering Code Right Hand	 L	D	D1	Min Bore Diam.	L	L1	F	Insert Screw	Clamp	Anvil Screw	Torx Key	RH Anvil	LH Anvil
DIR 0020 P16	16	20	20	24	170	-	13.7	S16	C16	A16S	K16	AI16	AE16
DIR 0025 R16	16	25	25	29	200	-	16.2	S16	C16	A16S	K16	AI16	AE16
DIR 0032 S16	16	32	32	36	250	-	19.7	S16	C16	A16S	K16	AI16	AE16
* DIR 0025 R22	22	25	25	29	200	-	18.1	S22	C22	A22	K22	AI22	AE22

For **LEFT HAND** toolholders specify DIL instead of DIR

Two clamping methods can be used: screw or top clamp.

*Use K21 torx key for C22 clamp

Toolholders with 3.5° Helix Angle

Ordering Code Right Hand	 L	D	D1	Min Bore Diam. mm	L	L1	F	Insert Screw	Torx Key
SIR 0016 P16B-3.5	16	20	16	19	170	40	13.7	S16S	K16
SIR 0020 P22B-3.5	22	20	20	24	170	-	15.6	S22S	K22

For **LEFT HAND** toolholders specify SIL instead of SIR

Carbide Shank Threading Bars With coolant bore

Carbide Shank Threading Bars are used when Chatter and deflection are expected due to long overhang in deep small bores.

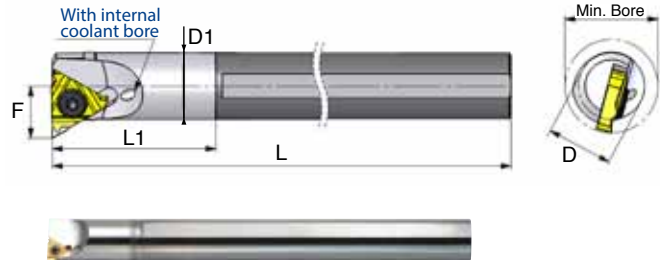

Ordering Code Right Hand	 L	D	D1	Min Bore Diam.	L	L1	F	Insert Screw	Anvil Screw	Torx Key	RH Anvil	LH Anvil
SIR 0010 M11CB	11	10	10	12	150	-	7.4	S11	-	K11	-	-
SIR 0012 P11CB	11	12	12	15	170	-	8.4	S11	-	K11	-	-
SIR 0016 R16CB	16	16	16	19	200	-	11.7	S16S	-	K16	-	-
*SIR 0020 S16CB	16	20	20	24	250	-	13.7	S16	A16	K16	AI16	AE16
*SIR 0025 S16CB	16	25	25	29	250	-	16.2	S16	A16	K16	AI16	AE16

*Carbide shank Threading bars with anvil
For **LEFT HAND** toolholders specify **SIL** instead of **SIR**

Vertical Toolholders

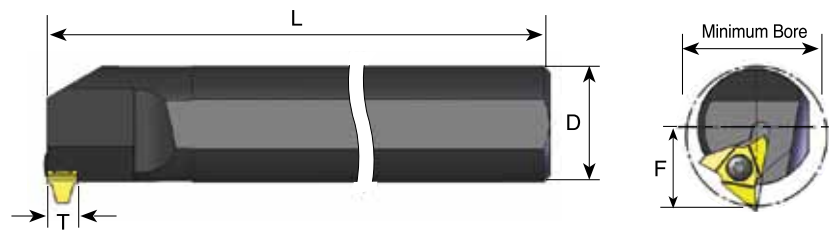

Ordering Code Right Hand	 L	D	* Min Bore Diam.	L	F	Insert Screw	Torx Key
SIR 0040T27V-T10	27	40	48	300	29	S27	K27
SIR 0050U27V-T10	27	50	58	350	34	S27	K27

For **LEFT HAND** toolholders specify **SIL** instead of **SIR**

* To be compare with given minimum bore profile.

Thread Helix Angle

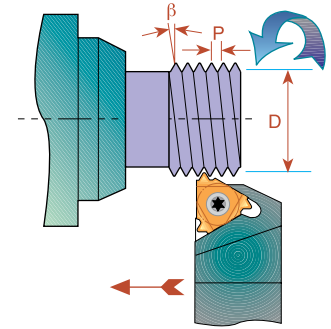
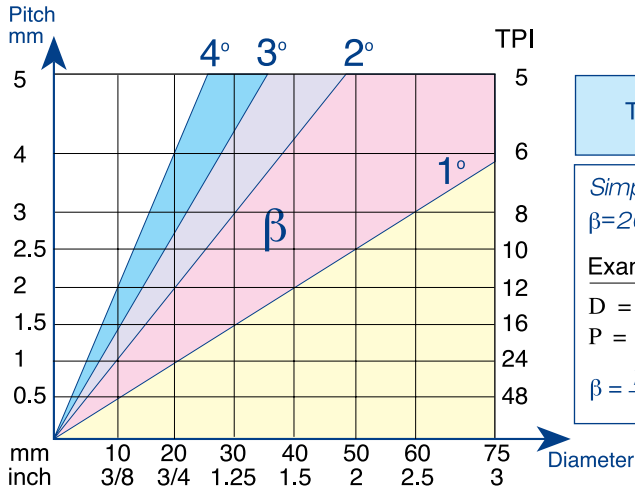

Standard and Slanted Anvils

CARMEX Toolholder Pockets have a built in 1.5° helix angle. This angle may be adjusted to better match the thread helix angle by simply changing the anvil.

Negative helix is usually used when threading RH thread with LH Holder or LH thread with RH Holder.

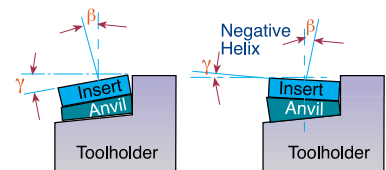

L	IC	Pocket Angle γ	4.5°	3.5°	2.5°	1.5° Standard	0.5°	-0.5°	-1.5°
16	3/8	EX-RH OR IN-LH	AE16+4.5	AE16+3.5	AE16+2.5	AE16	AE16+0.5	AE16-0.5	AE16-1.5
16	3/8	EX-LH OR IN-RH	AI 16+4.5	AI 16+3.5	AI 16+2.5	AI 16	AI 16+0.5	AI 16-0.5	AI 16-1.5
22	1/2	EX-RH OR IN-LH	AE22+4.5	AE22+3.5	AE22+2.5	AE22	AE22+0.5	AE22-0.5	AE22-1.5
22	1/2	EX-LH OR IN-RH	AI 22+4.5	AI 22+3.5	AI 22+2.5	AI 22	AI 22+0.5	AI 22-0.5	AI 22-1.5
22U	1/2U	EX-RH OR IN-LH	AE22U+4.5	AE22U+3.5	AE22U+2.5	AE22U	AE22U+0.5	AE22U-0.5	AE22U-1.5
22U	1/2U	EX-LH OR IN-RH	AI 22U+4.5	AI 22U+3.5	AI 22U+2.5	AI 22U	AI 22U+0.5	AI 22U-0.5	AI 22U-1.5
27	5/8	EX-RH OR IN-LH	AE27+4.5	AE27+3.5	AE27+2.5	AE27	AE27+0.5	AE27-0.5	AE27-1.5
27	5/8	EX-LH OR IN-RH	AI 27+4.5	AI 27+3.5	AI 27+2.5	AI 27	AI 27+0.5	AI 27-0.5	AI 27-1.5
27U	5/8U	EX-RH OR IN-LH	AE27U+4.5	AE27U+3.5	AE27U+2.5	AE27U	AE27U+0.5	AE27U-0.5	AE27U-1.5
27U	5/8U	EX-LH OR IN-RH	AI 27U+4.5	AI 27U+3.5	AI 27U+2.5	AI 27U	AI 27U+0.5	AI 27U-0.5	AI 27U-1.5

Important Points about Carmex Threading Inserts

1. In most thread forms internal and external threads have different depth and radii, thus tools are not interchangeable

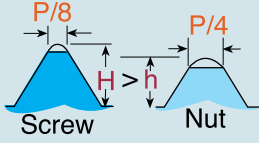

2. The Insert relief angle of a standard Carmex external toolholder is 10°; for an internal toolholder it is 15°. This 5° difference is to provide additional necessary radial clearance.

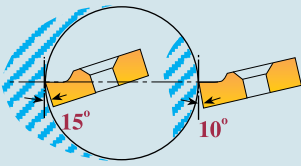

3. Our built-in relief angles ensure automatic insert flank angle clearance.

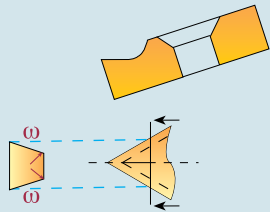

4. Profiles of Carmex internal & external threading inserts are precision ground to ensure accurate thread geometry when used in their corresponding toolholders. Using internal inserts with an external holder will result in distortion of angle and insert geometry.

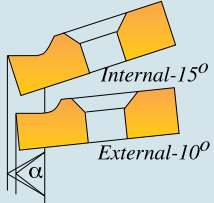

5. Insert and toolholder should always match. An IN-RH insert must be used with an IN-RH toolholder. No mismatch is allowed.



Flank Clearance Angle ω

$$\omega = \text{ArcTan} (\text{Tan } \alpha \times \text{Tan } \phi)$$

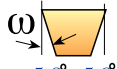
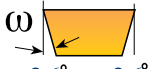
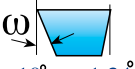
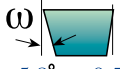
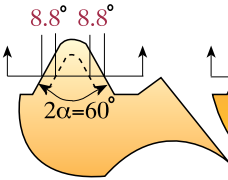
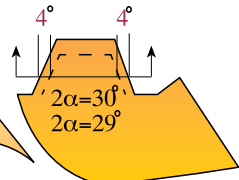
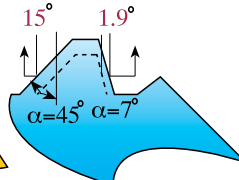
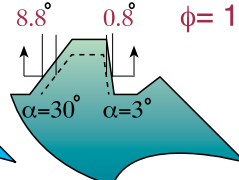
$\omega = 5.8^\circ \quad 5.8^\circ$ 	$\omega = 2.6^\circ \quad 2.6^\circ$ 	$\omega = 10^\circ \quad 1.24^\circ$ 	$\omega = 5.8^\circ \quad 0.5^\circ$ 	$\phi = 10^\circ$ for External toolholders			
$\omega = 8.8^\circ \quad 8.8^\circ$ 				$\phi = 15^\circ$ for Internal toolholders			
$2\alpha = 30^\circ$ $2\alpha = 29^\circ$ 		$\alpha = 45^\circ$ $\alpha = 7^\circ$ 		$\alpha = 30^\circ$ $\alpha = 3^\circ$ 			
ISO, UN PARTIAL 60 NPT		TRAPEZ ACME STACME		AMERICAN BUTTRESS		SAGE (DIN 513)	

Number of threading passes selection for single point inserts

Pitch:	mm TPI	0.5 48	0.8 32	1.0 24	1.25 20	1.5 16	1.75 14	2.0 12	2.5 10	3.0 8	4.0 6	6.0 4
Number of Passes		3-6	4-7	4-9	6-10	5-11	9-12	6-13	7-15	8-17	10-20	11-22

NOTES:

1. For most standard applications the middle of the range is a good starting point.
2. For most materials, the tougher the material, the higher the number of cutting passes you should select.
3. As a general rule of thumb, Fewer passes are better than more speed.

Thread Turning Methods

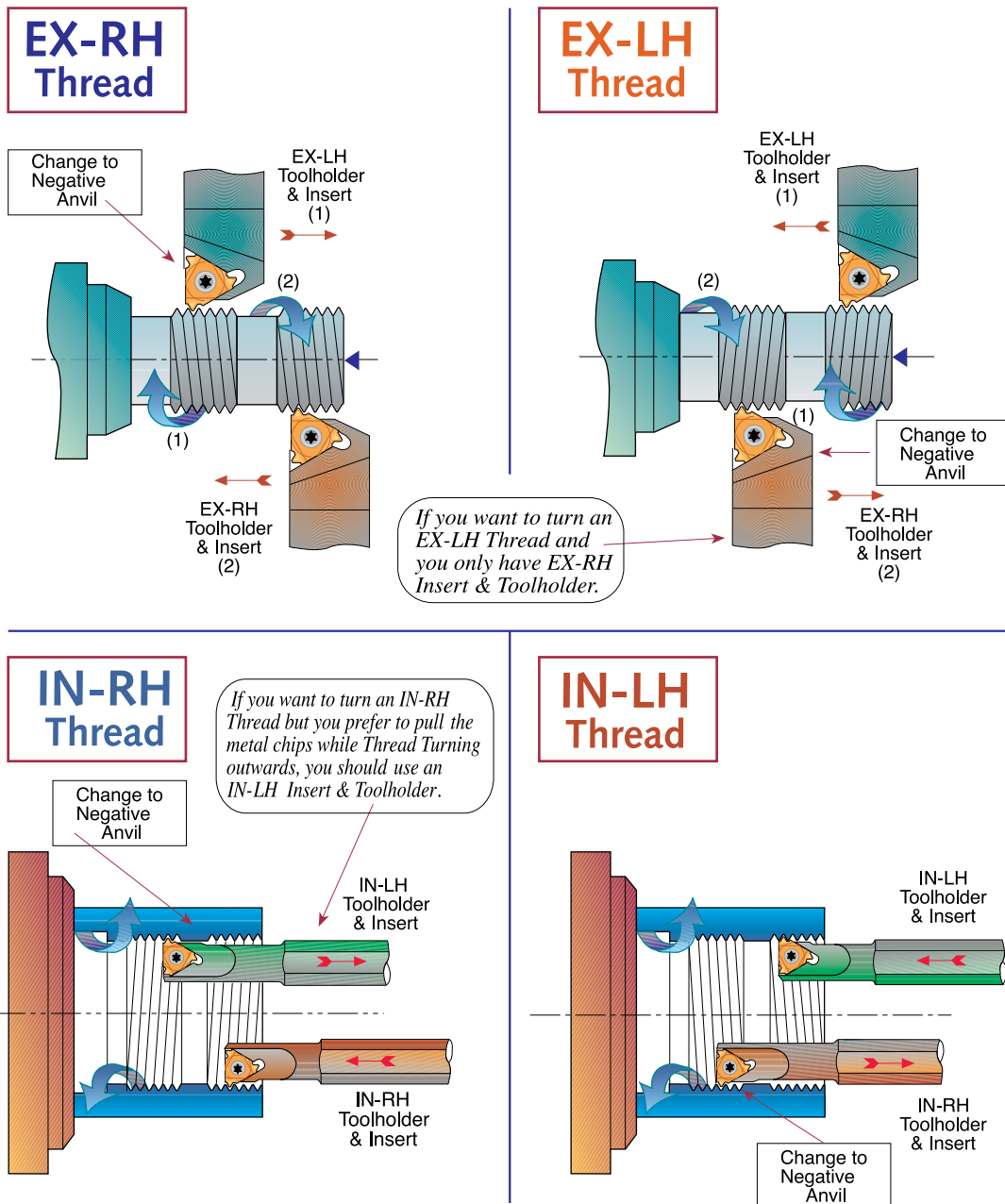

Conversion of Cutting Speed to Rotational Speed

Conversion of a selected cutting speed to rotational speed is calculated by the following formula:

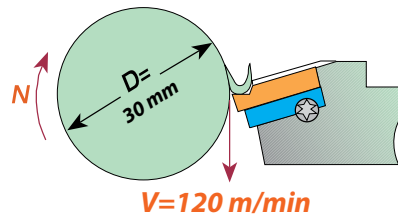

Example

$$N = \frac{V \times 1000}{\pi \times D} = \frac{120 \times 1000}{3.14 \times 30} = 1274 \text{ RPM}$$

Carbide Grade Selection

Choose the Carmex grade specifically formulated for your application from the following list:

Coated Grades

HBA (H10-H25) (S10-S25)	Extra-fine sub-micron grade with high toughness, for optimized performance on Hardened steels and Cast Iron up to 62HRc, Titanium Alloys and super alloys (Hastelloy, Inconel, and Nickel base alloys).
BLU (M10-M20) (K05-K20) (N10-N20) (S10-S20)	PVD triple layer coated sub-micron grade for stainless steels, cast iron, titanium, non ferrous metals and most of the high temperature alloys.
BMA (P20-P40) (K20-K30)	PVD TiAlN coated sub-micrograin grade for stainless steels and exotic materials at medium to high cutting speeds, Chasers application.
P25C (P15-P35)	PVD TiN coated grade for treated and hard alloy steels (25 HRc & up) at medium to low cutting speeds, Chasers application.
MXC (K10-K20) (P10-P25)	PVD TiN coated micrograin for free cutting untreated alloy steels (below 30 HRc), for stainless steels and cast iron.
BXC (P30-P50) (K25-K40)	PVD TiN coated grade for low cutting speed. Works well with wide range of stainless steels.

Note: Due to our unique and specialized production techniques, Carmex coated inserts provide superior cutting performance and exceptionally long tool life.

Grade availability per inserts size

Grade	HBA	BLU	BMA	P25C	MXC
Insert sizes	11, 16, 22, 27	11, 16, 22	11, 16, 22, 27, 33U, Type-B 11, 16	11, 16, 22, 27, 33U	11, 16, 22, 27, 33U

Type B - Threading Inserts

A combination of ground profile, and sintered chip-breaker threading inserts. Unlike most other manufactures' inserts, this combination ensures a consistent high quality thread, with precise shape and dimensions. Two different unique styles of chip-breaker were designed to suit the different specific requirements of Internal threads and External threads. All of Carmex Type B inserts are made of BMA Sub-Micrograin grade.



Recommended cutting speed (m/min) for thread turning inserts

ISO Standard	Material		Condition						
				HBA	BLU	BMA	P25C	MXC	
P	Non-Alloy Steel and Cast Steel, Free Cutting Steel	<0.25%C	Annealed		110-210	120-180	100-180	100-180	
		≥0.25%C	Annealed						
		<0.55%C	Quenched & Tempered						
		≥0.55%C	Annealed						
			Quenched & Tempered						
	Low Alloy Steel and Cast Steel (less than 5% alloying elements)		Annealed		90-140	80-130	70-120	70-120	
	High Alloy Steel, Cast Steel, and Tool Steel		Annealed		70-90	60-80	50-60	55-70	
M	Stainless Steel and Cast Steel		Ferritic / Martensitic		110-160	90-130	60-90	60-90	
			Martensitic						
			Austenitic						
K	Cast Iron Nodular (GGG)		Ferritic / Pearlitic		120-150	100-130		80-110	
			Pearlitic						
	Grey Cast Iron (GG)		Ferritic		140-150	120-130		90-100	
			Pearlitic						
	Malleable Cast Iron		Ferritic		110-140	100-130		80-100	
			Pearlitic						
N	Aluminum-Wrought Alloy		Not Cureable		700-1000			600-800	
			Cured						
	Aluminum-Cast, Alloyed		<=12% Si		280-750			200-550	
									Not Cureable
									Cured
	Copper Alloys		>12% Si		190-350			150-250	
									High Temperature
									Free Cutting
Non Metallic							200-300		
								Brass	
								Electrolytic Copper	
S	High Temp. Alloys, Super Alloys		Fe based		20-80	30-65	25-60		
									Annealed
									Cured
									Cast
	Titanium Alloys		Ni or Co based		30-60	40-50	35-45		
									Alpha +Beta Alloys Cured
H	Hardened Steel		Hardened 45-50 HRc		30-60	40-50	35-45		
			Hardened 51-55 HRc						
			Hardened 56-62 HRc						
	Chilled Cast Iron		Cast		20-50	30-40	25-35		
Cast Iron		Hardened		20-40	20-30	15-25			



1st Hacharoshet St., Maalot Industrial Zone 2101302, ISRAEL
Tel: (972) 4-9077400, Fax: (972) 4-9077440.
E-mail: info@carmex.com Website: www.carmex.com
Postal address: P.O. Box 404, Maalot 2101302, ISRAEL.